

infinitaconcept
Soluções de alta performance

COZINHA | CUBAS

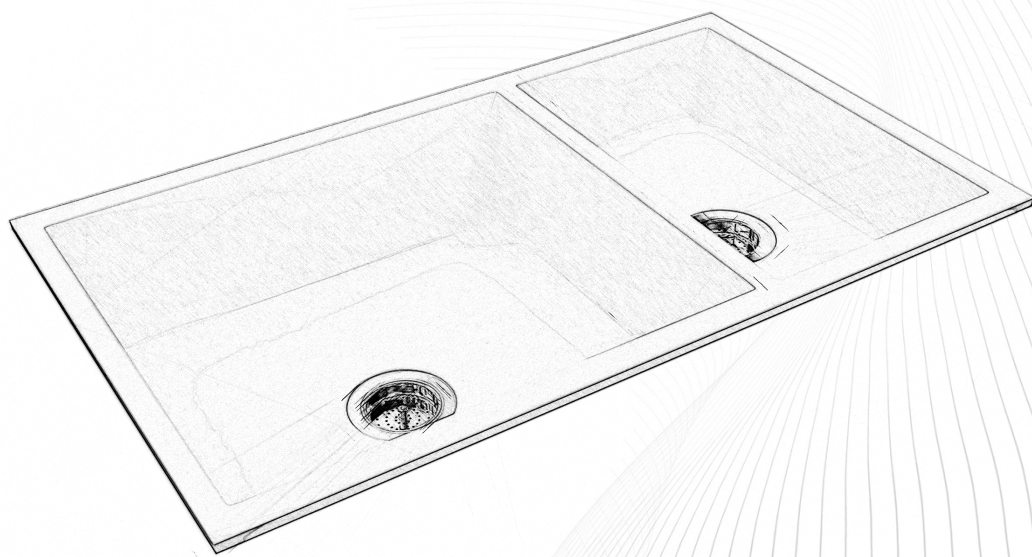

CUBAS CD001

A cuba CD001 foi desenvolvida para módulos de mobiliário de no mínimo 90x60cm e 90x65cm. O produto vem com cubas duplas (de mesmo tamanho e profundidade 19cm).

CD 001 - 600

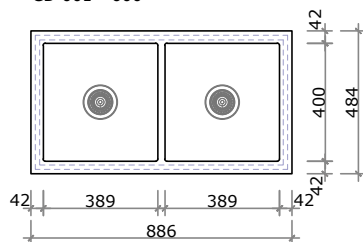

CD 001 - 650

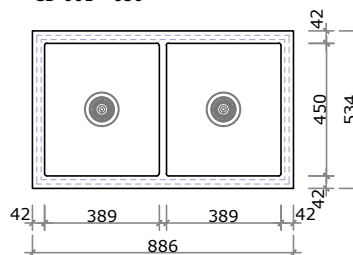

Vista frontal - Cubas

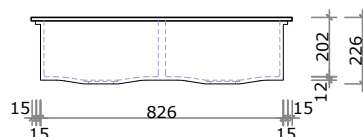

SUGESTÃO DE VÁLVULA
Válvula de escoamento
para pia de cozinha
1622 - 4 1/2 - DECA



CUBAS
CD002

A cuba CD002 foi desenvolvida para módulos de mobiliário de no mínimo 90x60cm e 90x65cm. O produto vem com cubas duplas (sendo a cuba principal com 19cm de profundidade e a cuba auxiliar com 13cm de profundidade).

CD 002 - 600

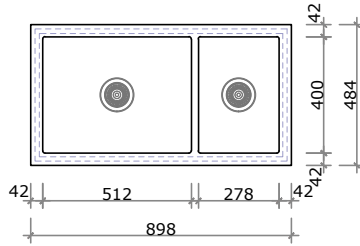

CD 002 - 650

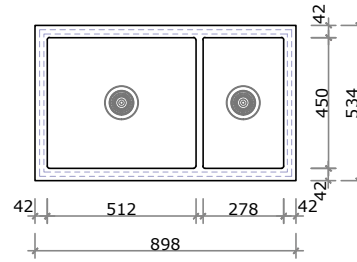

Vista frontal - Cubas

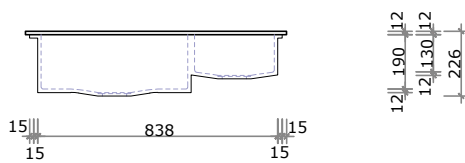

SUGESTÃO DE VÁLVULA
Válvula de escoamento
para pia de cozinha
1622 - 4 1/2 - DECA



CUBA
CS003

A cuba CS003 foi desenvolvida para módulos de mobiliário de no mínimo 80x60cm e 80x65cm. O produto vem com cubas duplas (sendo uma cuba centralizada e com 19cm de profundidade).

CS 003 - 600

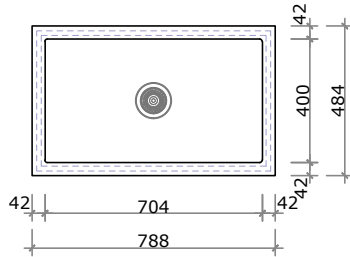

CS 003 - 650

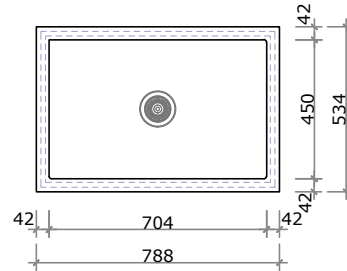

Vista frontal - Cubas

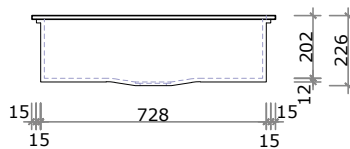

SUGESTÃO DE VÁLVULA
Válvula de escoamento
para pia de cozinha
1622 - 4 1/2 - DECA



CS004

A cuba CS004 A foi desenvolvida para módulos de mobiliário de no mínimo 80x60cm e 80x65cm. O produto vem com cubas duplas (sendo uma cuba com 19cm de profundidade).

CS 004 - 600

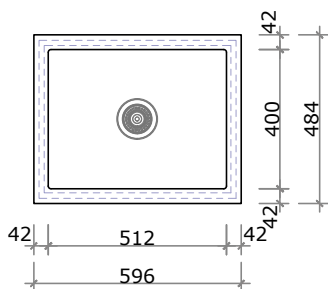

CS 004 - 650

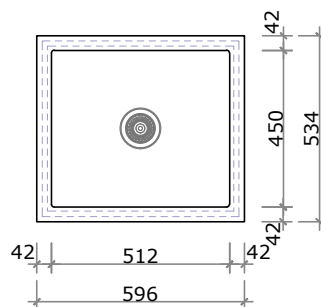

Vista frontal - Cubas

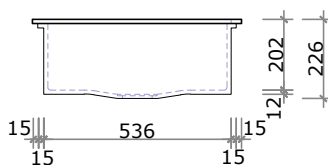

SUGESTÃO DE VÁLVULA
Válvula de escoamento
para pia de cozinha
1622 - 4 1/2 - DECA

